

G41JCS01XX Series Tubocolor

23" Antimicrobial vinyl coated folding and rotating grab bar. No pinch flange and follows commercial child safety protocol. No maintenance 3mm thick antimicrobial vinyl coating. Stainless steel mounting plate concealed by ABS flange cover.

Mounting hardware not supplied.

Product Data

Overall Dimensions (Inch.)	4-7/16 x 23-5/8 x 9-3/16
Net Weight (lbs.)	6.61

Installation Hardware Details

Packaging Details

Package	LDPE bag in cardboard box
Package dimensions (Inch.)	5-1/8 x 24-13/16 x 8-11/16
Weight with Packaging (lbs.)	7.5

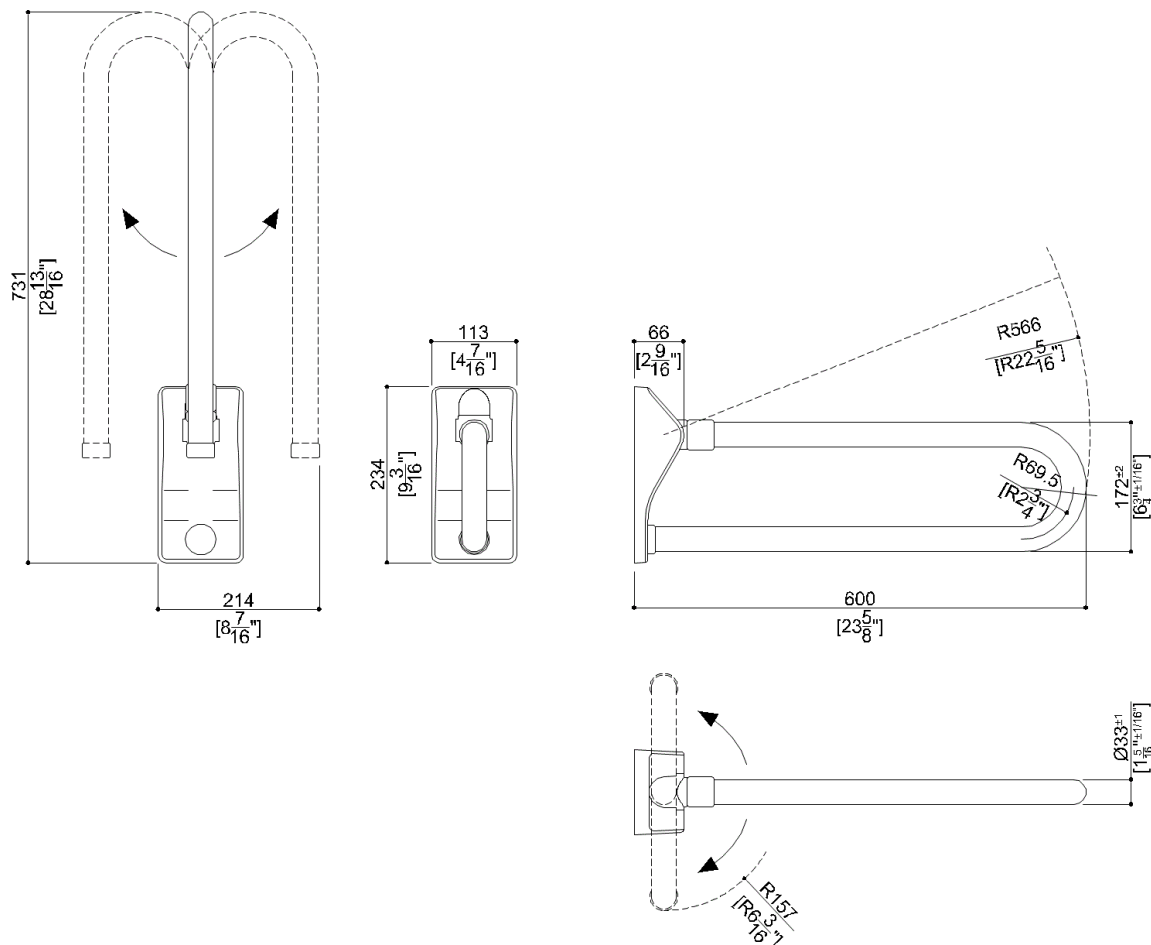







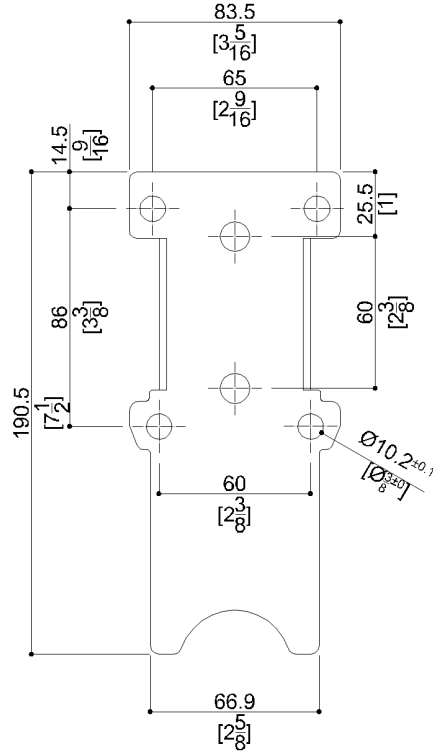

G41JCS01XX Series Tubocolor

Y88JKS77

AISI304 stainless steel fixing plate



Available Finishes (xx)

 B1 Blue	 D1 Black	 D2 Greystone
 D4 Dark Gray	 I2 Biscuit	 P4 Prune
 R7 Ruby red	 W1 White	 Y3 Light Yellow

Load Capacity

Vertical 331 lbs.

Warning

Before installation and use, read the installation and use instructions in their entirety. If questions arise please contact Ponte Giulio company.

Cleaning

Product can be cleaned with a cloth and warm soapy water. Non abrasive, solvent free cleaners can also be used.

Warranty

Please visit www.pontegiulio.com for complete warranty details.

Materials and finishes

Steel	Rough
Stainless Steel	Rough
Polyamide	Polished
Vinyl	Polished