



# Auto Soap Dispenser

Model No.: 6A00-110000

## 1. SPECIFICATIONS:

• Dimensions (W x H x D)	4-41/64" x 10-17/32" x 4-11/64" (117.75mm x 267.54mm x 106.09mm)
• Soap Tank Capacity { fl oz(ml)}	27 (800)
• Battery Type Required Battery Life Estimated	Alkaline (1.5V) AA size, Qty 4 100,000 cycles or 1 year
• Room Temperature { °C(°F)}	5 ~ 40 (41 ~ 104)
• Sensing Delay Time (msec)	500 ~ 1k
• Dispensing Volume { fl oz(ml)}	0.034 ~ 0.051 (1 ~ 1.5)
• Applicable Viscosity Range {cP(mPas)}	1 ~ 3000 (1 ~ 3000)
• Unit Net Weight empty { oz(kg)} Operation Mode	24.7 (0.7)
• Supply	Automatic from Sensor Trigger
• Reservoir Types	800 ml reusable (included), disposable (supplied by others)
• Pump Type	Peristaltic Tube (self contained valve/nozzle)

## 2. RECOMMENDED INSTALLATION:

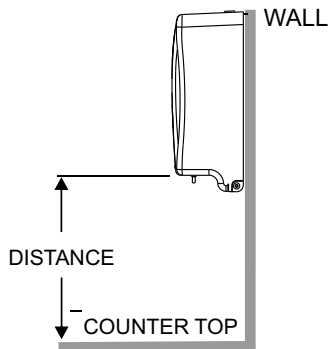

DISTANCE (MINIMUM TYPICAL)  
NORMAL COUNTER TOP  
 At least 7-7/8" (200mm)  
STAINLESS STEEL COUNTER TOP  
 At least 11-13/16" (300mm)

### 3.1 INSTALLATION STEPS, Tile or Dry Wall

1. Tape the installation template at the appropriate location on the mounting surface.
2. Drill four (4) holes at marked locations Ø5/16" diameter (8mm).
3. Insert four (4) plastic anchors (supplied) into drilled holes; remove template (fig. 1).
4. Insert two (2) screws (supplied) into top plastic anchors and leave 1/8" (3mm) space from the wall under head (fig. 2 and fig. 3) for hanging dispenser.
5. Hang the dispenser on the two (2) screws through the keyhole slots at backplate top.
6. Use key to unlock and pull forward the housing cover (fig. 4).
7. Remove soap reservoir and lock dispenser to wall with remaining two (2) screws (supplied) through the holes at backplate bottom. Tighten all screws (fig. 5).

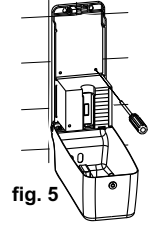
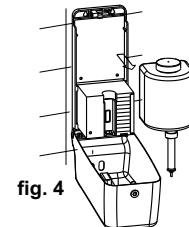
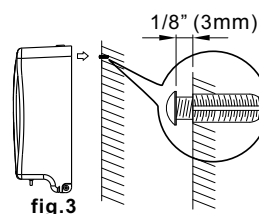
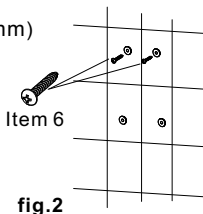
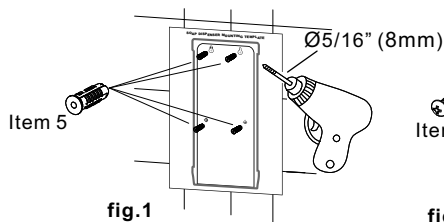

### 3.2 INSTALLATION STEPS, Adhesive on Mirror

1. Clean mounting surface in area to be installed with isopropyl alcohol.
2. Mark outline of dispenser on mirror with masking tape.
3. Remove paper liners from self-adhesive pads on dispenser backplate.
4. Place unit on mounting surface with even steady pressure and hold for 1 minute.
5. Let tape cure for 10 hours prior to filling dispenser with soap for use.

## 4. OPERATION INSTRUCTIONS

1. Open housing with included security key previously retained.
2. Open cover on battery compartment, remove battery box and unplug cable; install four (4) new Alkaline Type AA 1.5V batteries with correct polarity (note the +/- indication) to obtain 6.0 DC  $\pm$  10% at the plug.
3. Reinstall battery box and close compartment cover
4. Obtain a disposable soap cartridge (950ml) or remove, clean out and refill the included reusable soap reservoir with the correct viscosity liquid soap (ensure that soap container cover is closed and air vent hole is open and nozzle is not clogged and that soap container is clean (no spill-over) and not leaking) and install either in the dispenser. Make sure the nozzle flange is below the housing cradle rib to stretch the valve tube.
5. Make sure to latch the cradle gate.
6. Observe that the LED is lit blue and then flashes fore (4) times dicating proper operation "stand-by" condition and battery charge level (push up the cover safety interlock switch (blue stem) on bottom to click and hold it).
7. Close the housing cover and lock it with the included security key previously retained.
8. Trigger the sensor with hands or a towel to check proper soap dispensing cycle .

## 5. IMPORTANT NOTICE

1. Ensure no bright source is aimed or reflected at the sensor from below.
2. Use fresh new liquid soap only and clean the soap container properly before each re-fill. Deposits of old soap will lead to malfunction and jamming.
3. Do not dilute liquid soap unless concentrate and do not use soap containing abrasive. Observe indicated viscosity factor of liquid soap.
4. Do not immerse the soap dispenser in water or clean it under running water. This will lead to short circuit.
5. Should the dispenser be out of order and batteries have been replaced, do not attempt any repair work. Call your dealer for professional assistance.

## 6. BATTERY LOW INDICATION

With housing cover open and soap reservoir removed (see Instructions) perform the following diagnostic test:

1. Press and push up the cover safety interlock switch (blue stem) on bottom to click and hold it.
2. Observe that the LED is lit blue and then flashes fore (4) times indicating proper operation "stand-by" condition and battery charge level.
3. If LED continues to flash blue the indication is positive to replace the batteries.

Caution : Batteries installed with incorrect polarity may cause malfunction.

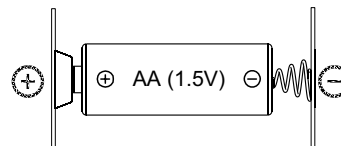

## 7. PARTS LIST

### NO. DESCRIPTION

1. Security key
2. Sensor assembly
3. Led indicator for low battery
4. Battery Box
5. Housing

### CONTAINER ASSEMBLY:

6. Tank cover
7. Soap tank
8. Connector between plastic pipe and container
9. Plastic pipe
10. Nozzle
11. Nozzle cap

### FOR INSTALLATION:

12. Two Holes (for Hanging Up The Dispenser)
13. Back Plate

