

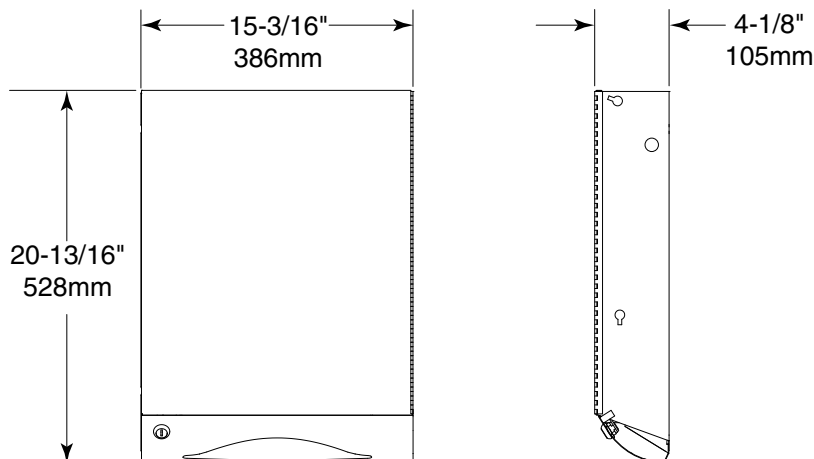

Technical Data

ClassicSeries® CONVERTIBLE FOLDED TOWEL DISPENSER MODULE

3944-52



Line art shown without door in place

MATERIALS:

Cabinet — 18-8, type-304, 22-gauge (0.8mm) stainless steel with satin-finish on exposed surfaces. All welded construction. Rounded towel tray has hemmed opening to dispense paper towels without tearing. Capacity: 600 C-fold or 800 multifold paper towels with a semi-concealed tumbler lock keyed like other Bobrick washroom accessories.

Door — 18-8, type-304, 22-gauge (0.8mm) stainless steel with satin-finish. Double-pan-back construction. Secured to cabinet with a full-length stainless steel piano-hinge.

OPERATION:

Paper towel dispenser accommodates C-fold or multifold paper towels without adjustment or use of adapters. To adapt to changing needs of washrooms, this unit is field convertible with the Universal Touch-Free Roll Towel Module or Automatic, Universal Touch-Free Roll Towel Module. To order convertible modules, reference part numbers below under Options.

Options:

- Universal Touch-Free Roll Towel Dispenser Module convertible in field: order Bobrick Part No. 3961-50.
- Automatic, Universal Roll Towel Dispenser Module convertible in field: order Bobrick Part No. 3974-50.

INSTALLATION:

Remove existing dispenser module, then install new folded towel dispenser module per Form No. 3944-69. For removal of Universal Roll Towel Dispenser Module refer to Form No. 3961-69. For removal of Automatic, Universal Roll Towel Dispenser Module refer to Form No. 3974-69.

SPECIFICATION:

Convertible folded towel dispenser module shall be type-304 stainless steel with all-welded construction; exposed surfaces shall have satin finish. Door shall be secured to cabinet with a full-length stainless steel piano-hinge and equipped with a semi-concealed tumbler lock keyed like other Bobrick washroom accessories. Paper towel dispenser shall dispense 600 C-fold or 800 multifold paper towels.

Convertible Folded Towel Dispenser Module shall be Model 3944-52 of Bobrick Washroom Equipment, Inc., Clifton Park, New York; Jackson, Tennessee; Los Angeles, California; Bobrick Washroom Equipment Company, Scarborough, Ontario; Bobrick Washroom Equipment Pty. Ltd., Australia; and Bobrick Washroom Equipment Limited, United Kingdom.